

2×50W D类立体声音频功放

2×50W Class D Stereo Amplifier

■ FEATURES

- Output Power (BTL)
 - 2×40W (VDD=18V, RL=4Ω, THD+N=10%)
 - 2×50W (VDD=24V, RL=6Ω, THD+N=10%)
 - 2×40W (VDD=24V, RL=8Ω, THD+N=10%)
- Output Power (PBTL)
 - 80W (VDD=24V, RL=4Ω, THD+N=10%)
 - 100W (VDD=24V, RL=3Ω, THD+N=10%)
- Single Wide Voltage Supply: 4.5V-26V
- Efficiency > 90%
- Spread spectrum function
- Differential / Single-ended Analog Input, BTL or PBTL Output
- Selectable Gain: 32dB or 26dB
- Integrated Self-protection Circuits Including Overvoltage, Undervoltage, Overtemperature, DC-detect, and Overcurrent with Error Reporting
- LF and HF Package of ETSSOP28
- 输出功率 (BTL)
 - 2×40W (VDD=18V, RL=4Ω, THD+N=10%)
 - 2×50W (VDD=24V, RL=6Ω, THD+N=10%)
 - 2×40W (VDD=24V, RL=8Ω, THD+N=10%)
- 输出功率 (PBTL模式)
 - 80W (VDD=24V, RL=4Ω, THD+N=10%)
 - 100W (VDD=24V, RL=3Ω, THD+N=10%)
- 单电源系统, 4.5V-26V宽电压输入范围
- 超过90%效率, 无需散热器
- 扩频功能
- 模拟差分/单端输入, 输出模式立体声/单声道可选
- 可选增益: 32dB/26dB
- 保护功能: 过压/过流/过热/欠压异常, 直流检测和短路保护
- 无铅无卤封装, ETSSOP28

■ APPLICATIONS

- Sound Bars
- Wireless Speakers
- 条形音箱
- 无线智能音箱
- Consumer Audio Applications
- TVs/Monitors
- 便携式音箱
- 消费类音频应用
- 拉杆音箱
- LCD电视/监视器

■ DESCRIPTION

HT338 is a stereo efficient, Class-D audio amplifier for driving speakers up to 50W/6 Ω in stereo BTL. It can also deliver 100W/3Ω power in stereo PBTL.

Spread spectrum function is available to achieve advanced EMI Suppression.

The built-in shutdown function can minimize the standby current of HT338. HT338 is fully protected against faults with Overvoltage, Undervoltage, Overtemperature, DC-detect, and Overcurrent protection. Faults can be reported to the processor to prevent devices from being damaged.

HT338是一款高效D类音频功率放大器。在24V供电的立体声 (BTL)、THD+N=10%条件下, 能够持续提供2×40W/6 Ω 功率输出; 在单声道 (PBTL)、模式、THD+N=10%条件下, 能够持续提供100W/3 Ω 功率输出。

HT338具有先进的扩频功能来抑制EMI。此外, HT338内置关断功能使待机电流最小化, 还集成了过压保护、直流保护、短路保护、热保护和电源欠压异常保护等功能, 可全面防止出现故障。

■ TYPICAL APPLICATION

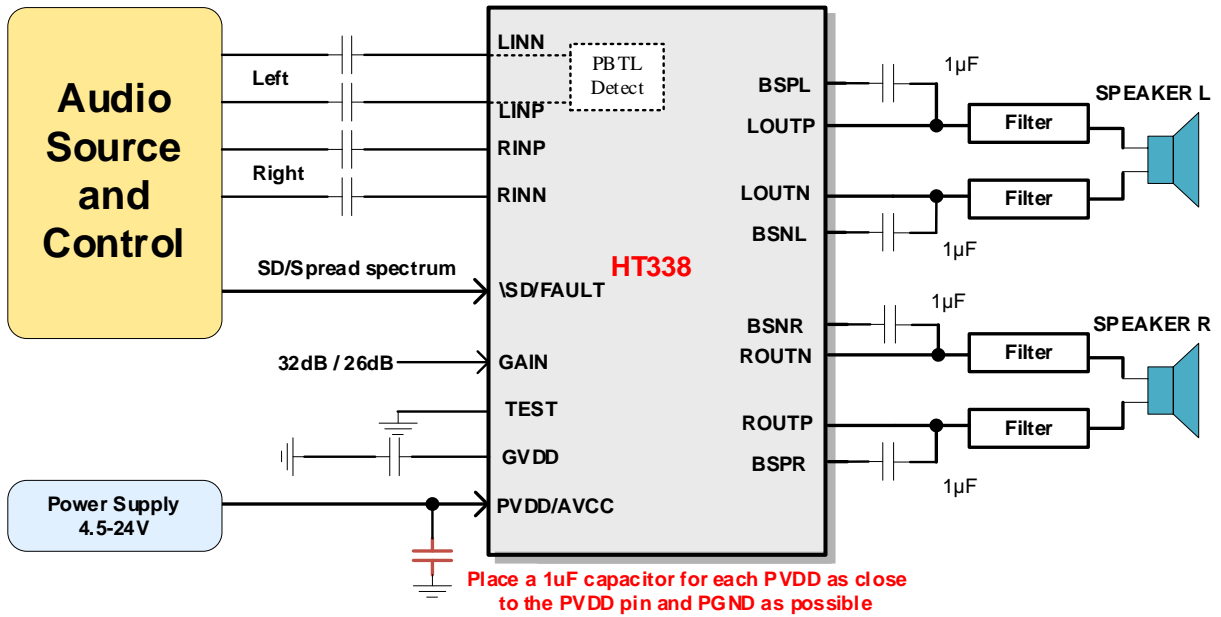

ORDERING INFORMATION

Part Number	Package Type	Marking	Operating Temperature Range	Shipping Package / MOQ
HT338MTER	ETSSOP28 (MTE)	HT338 YYYMAAB ¹	-40°C ~ 85°C	Tape and Reel (R) / 3000pcs

Part Number

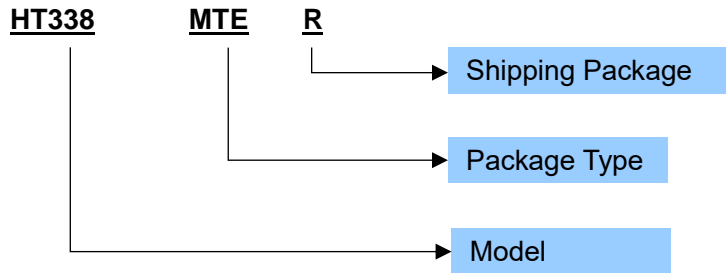

Production Tracking Code

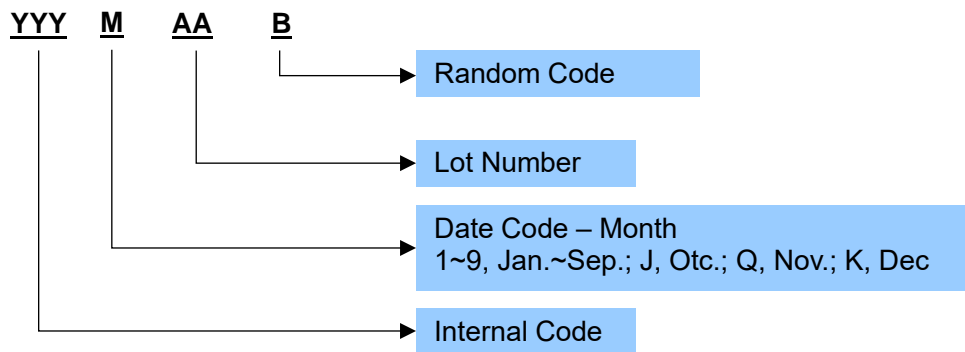

¹ YYYMAAB is production tracking code
Copyright©2023, Heroic Technology

■ TERMINAL CONFIGURATION

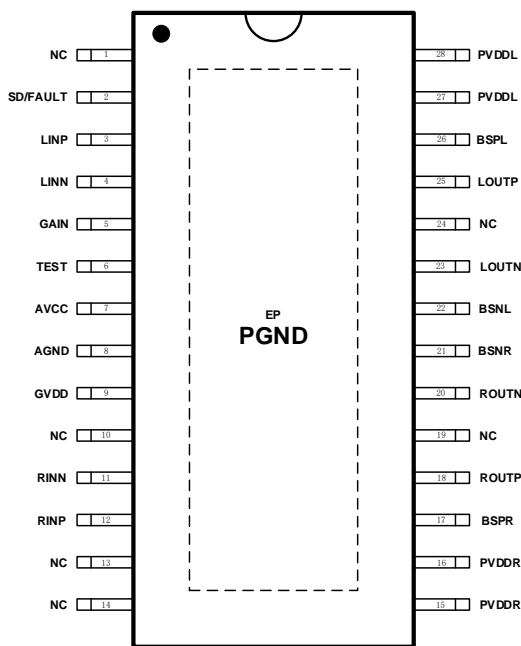

HT338 Top View

■ TERMINAL FUNCTION

Terminal No.	Name	I/O ¹	Description
2	\SD/FAULT	I	SD/FAULT, multi-function pin. When pulled down, place the speaker amplifier in shutdown mode. General fault reporting including Over-Temp, Over-Current, DC Detect.
3	LINP	I	Positive input terminal for L channel
4	LINN	I	Negative input terminal for L channel
5	GAIN	I	Gain select pin. Low = 26dB gain; High or floating = 32dB
6	TEST	I	Test mode select pin. Connect to GND
7	AVCC	P	Analog power supply.
8	AGND	G	Analog signal GND. Connect to PGND.
9	GVDD	O	Voltage regulator derived from AVDD supply, connect 1uF to GND
11	RINN	I	Negative input terminal for R channel
12	RINP	I	Positive input terminal for R channel
15/16	PVDDR	P	Power Supply for amplifier drivers of R channel
17	BSPR	BST	Connection point for the ROU TP bootstrap capacitor, which is used to create a power supply for the high-side gate drive for ROU TP
18	ROU TP	O	Positive pin for differential speaker amplifier output R
20	ROU TN	O	Negative pin for differential speaker amplifier output R
21	BSNR	BST	Connection point for the ROU TN bootstrap capacitor, which is used to create a power supply for the high-side gate drive for ROU TN
22	BSNL	BST	Connection point for the LOU TN bootstrap capacitor, which is used to create a power supply for the high-side gate drive for LOU TN
23	LOU TN	O	Negative pin for differential speaker amplifier output L
25	LOU TP	O	Positive pin for differential speaker amplifier output L
26	BSPL	BST	Connection point for the LOU TP bootstrap capacitor, which is used to create a power supply for the high-side gate drive for LOU TP
27/28	PVDDL	P	Power Supply for amplifier drivers of L channel
1/10/13/ 14/19/24	NC	-	NC, Connect to Ground for better thermal performance
EP	GND	G	Provides both electrical and thermal connection from the device to the board. A matching ground pad must be provided on the PCB and the device connected to it via solder. For proper electrical operation, this ground pad must be connected to the system ground. 既是地，又是散热PAD

¹ I: Input; O: Output; G: Ground; P: Power; BST: BOOT Strap;

■ SPECIFICATIONS¹

● Absolute Maximum Ratings²

PARAMETER	Symbol	MIN	MAX	UNIT
Supply voltage range (PVDD, AVCC)	PVDD	-0.3	27	V
Input voltage range (LINP, LINN, RINP, RINN, \SD, TEST, GAIN)	V _I	-0.3	5.8	V
Operating temperature range	T _A	-40	85	°C
Operating junction temperature range	T _J	-40	150	°C
Storage temperature range	T _{STG}	-50	150	°C

● Recommended Operating Conditions

PARAMETER	Symbol	CONDITION	MIN	TYP	MAX	UNIT
Supply voltage range	V _{DD}	PVDD, AVCC	4.5		26	V
Operating temperature	T _a		-40	25	85	°C
High-level input voltage	V _{IH}	\SD terminal, spread spectrum enabled	2.5		5.5	V
Middle-level input voltage	V _{IM}	\SD terminal, spread spectrum disabled	1.8		2.1	V
Low-level input voltage	V _{IL}	\SD terminal, shutdown			0.5	V
High-level input voltage	V _{IH}	GAIN, TEST	1.5		5.5	V
Low-level input voltage	V _{IL}	GAIN, TEST			0.8	V
Low-level output voltage	V _{OL}	\SD/Fault terminal, when fault occurs, OPEN-DRAIN OUTOUT			0.5	V
Load impedance (BTL)	R _L	With output filter		4		Ω
Load impedance (BTL)	R _L	With output filter		3		Ω

● Electrical Specification³

- Conditions: T_A = 25°C, PV_{DD} = 4.5-26V, Load = 4ohm, unless otherwise specified.

PARAMETER	Symbol	CONDITION	MIN	TYP	MAX	UNIT
Class Output Offset Voltage	V _{OS}	V _I = 0V, Gain = 32dB		1.5		mV
Quiescent supply current	I _{DD}	V _{DD} = 12V, filter = 10uH+680nF, Load = 4ohm		19		mA
Quiescent supply current in SD mode	I _{SD}	V _{DD} = 12V, With Load		10		uA
System Gain	Gain	GAIN=H or floating		32		dB
		GAIN=L		26		dB
Turn-on time	t _{on}	Pull \SD high or power on		100		ms
Turn-off time	t _{off}	Pull \SD low		5		us
Gate drive supply	GVDD			5		V

¹ Depending on parts and PCB layout, characteristics may be changed.

² Stresses beyond those listed under absolute maximum ratings may cause permanent damage to the device. These are stress ratings only, and functional operation of the device at these or any other conditions beyond those indicated under recommended operating conditions is not implied. Exposure to absolute-maximum-rated conditions for extended periods may affect device reliability.

³ Depending on parts and pattern layout, characteristics may be changed.

Conditions: $T_A = 25^\circ\text{C}$, $PV_{DD} = 4.5\text{-}24\text{V}$, Load = Filter + R_L , Filter = $10\mu\text{H} + 680\text{nF}$, $R_L = 4\Omega$, $f_{IN} = 1\text{ kHz}$, Gain = 26dB, $C_{IN} = 1\mu\text{F}$, 20-20kHz, unless otherwise specified.

PARAMETER	Symbol	CONDITION	MIN	TYP	MAX	UNIT	
Continuous output power	P_o	BTL, VDD = 18V, $R_L = 4\Omega$	THD +N = 1%		34		W
			THD+N = 10%		42		W
		BTL, VDD = 24V, $R_L = 6\Omega$	THD +N = 1%		43		W
			THD+N = 10%		53		W
		PBTL, VDD=24V, $R_L = 4\Omega$	THD +N = 1%		66		W
			THD+N = 10%		82		W
PBTL, VDD=24V, $R_L = 3\Omega$	THD +N = 1%		82		W		
	THD+N = 10%		100		W		
Total harmonic distortion + noise	THD+N	$P_o = 1\text{W}$, $V_{DD} = 12\text{V}$, $R_L = 4\Omega$		0.05		%	
Efficiency	η	VDD = 12V, THD+N = 10%	$R_L = 4\Omega$, BTL		92		%
		VDD = 16V, THD+N = 10%	$R_L = 4\Omega$, BTL		91		%
		VDD = 24V, THD+N = 10%	$R_L = 6\Omega$, BTL		92		%
		VDD = 24V, THD+N = 10%	$R_L = 8\Omega$, BTL		94		%
		VDD = 24V THD+N = 10%	$R_L = 4\Omega$, PBTL		95		%
Cross Talk	CT	$P_o = 1\text{W}$, Gain = 20dB, 1kHz		-80		dB	
Output integrated noise	V_N	A-weighted, Gain = 26 dB		100		μV	
Power supply rejection ratio	PSRR	200mVpp 1kHz, Input grounded		-75		dB	
Oscillator frequency	f_{osc}			360		kHz	
Over temperature protection trigger point	OTP			150		$^\circ\text{C}$	
Over current trip point	OCP			8		A	

TYPICAL OPERATING CHARACTERISTICS

V_{DD} = 12V, Load = 4ohm, filter = 10uH+0.68uF, BTL, unless otherwise specified.

V_{DD} vs I_{DD}

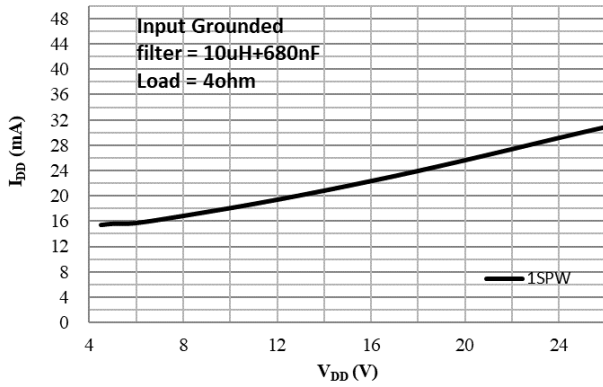

V_{DD} vs I_{SD}

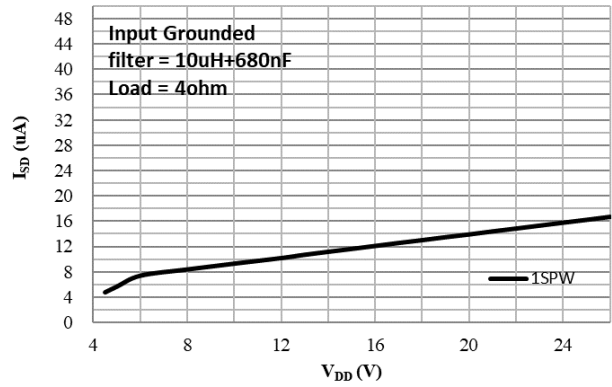

V_{DD} vs P_O

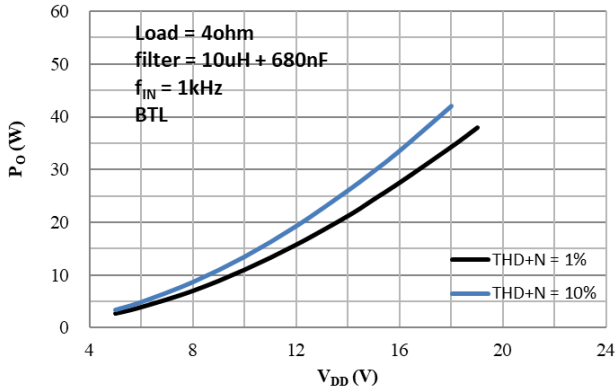

V_{DD} vs P_O

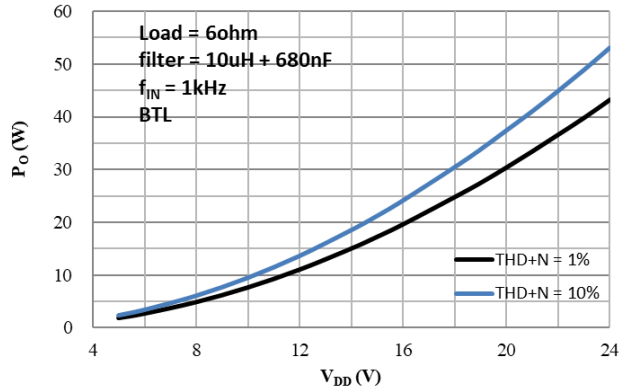

V_{DD} vs P_O

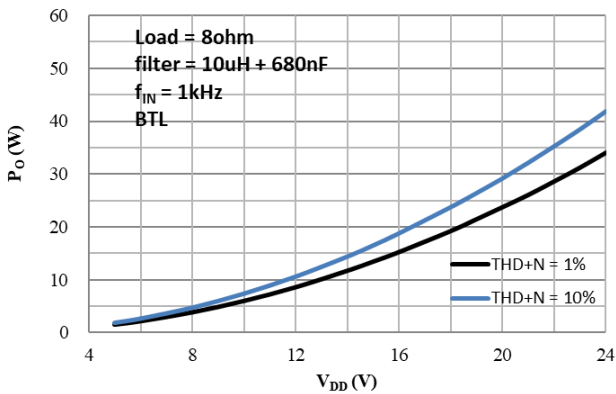

V_{DD} vs P_O

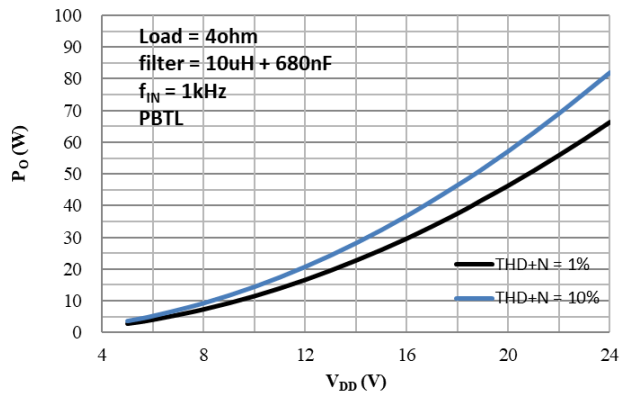

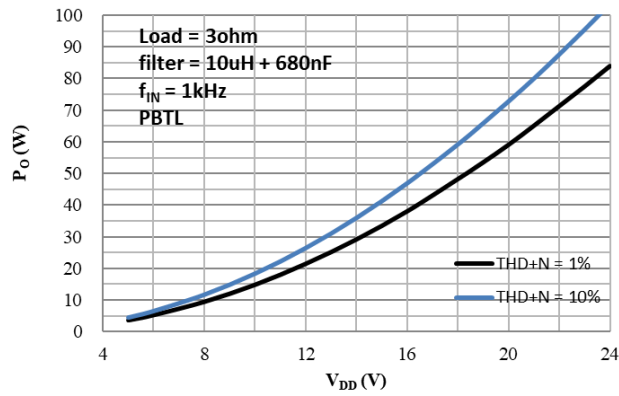
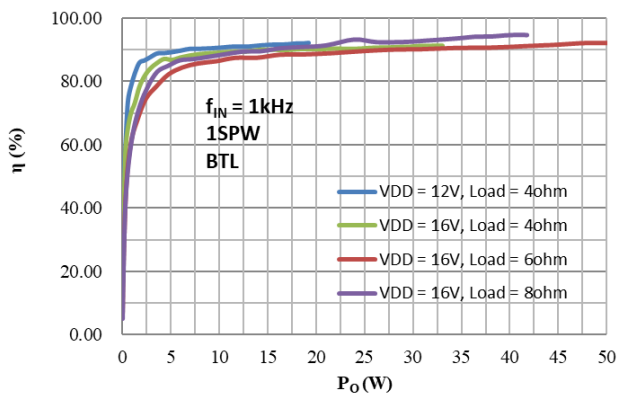
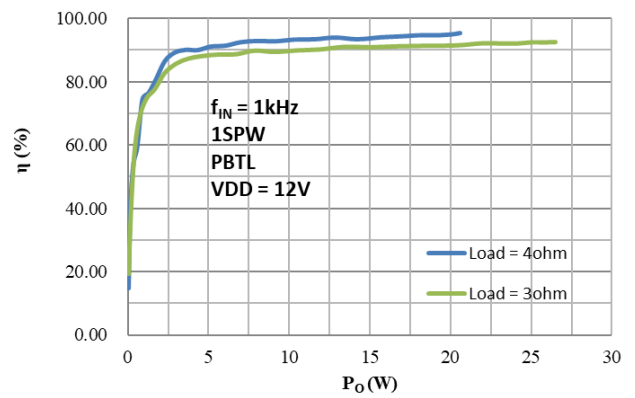
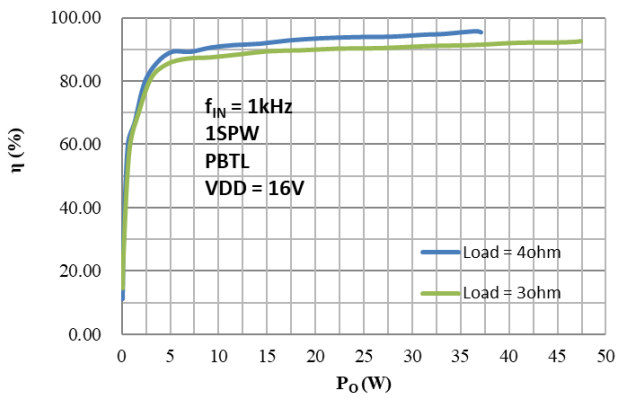
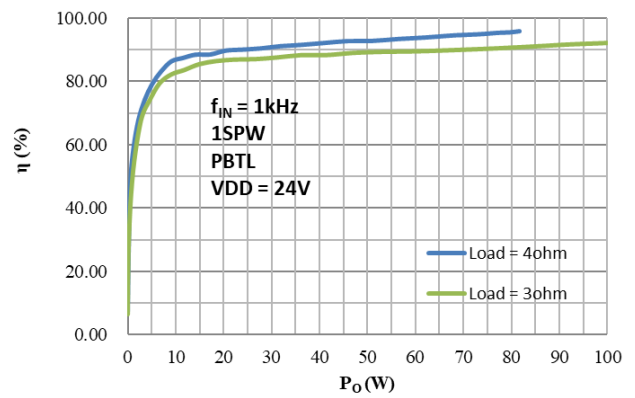
V_{DD} vs P_O

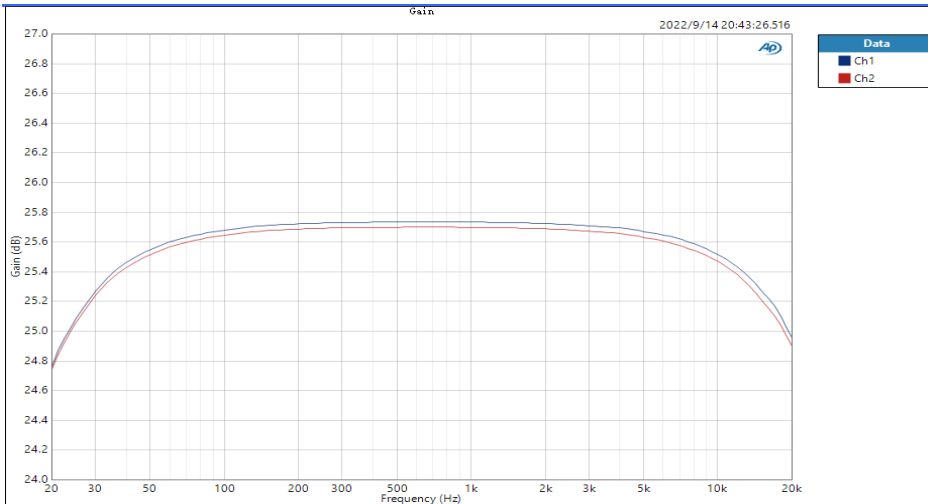
 P_O vs η

 P_O vs η

 P_O vs η

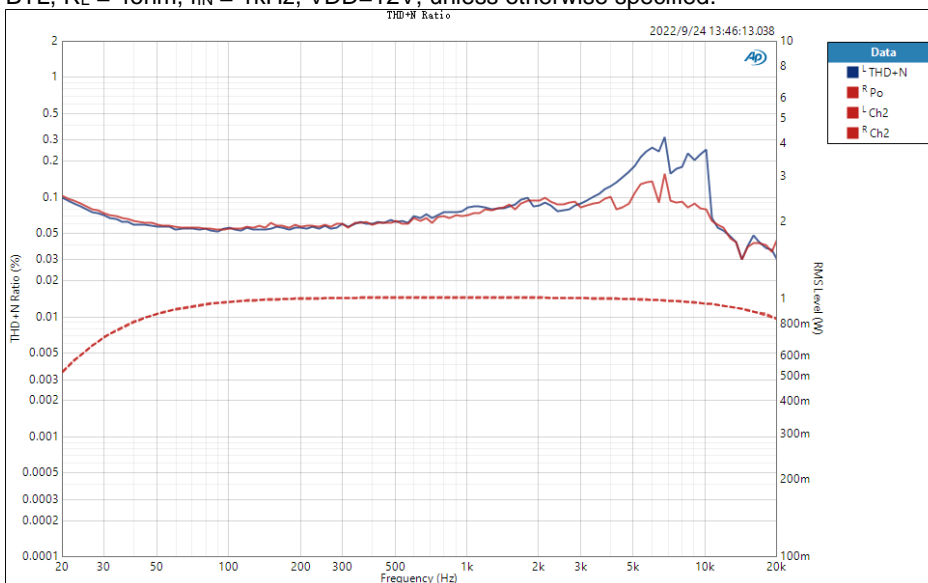
 P_O vs η



Frequency response
($C_{in} = 1\mu F$, Gain=L, Load = 4ohm, filter = 10uH+0.68uF)

BTL, $R_L = 4\text{ohm}$, $f_{IN} = 1\text{kHz}$, $V_{DD} = 12\text{V}$, unless otherwise specified.



frequency vs THD+N
($P_o \approx 2 \times 1\text{W}$)

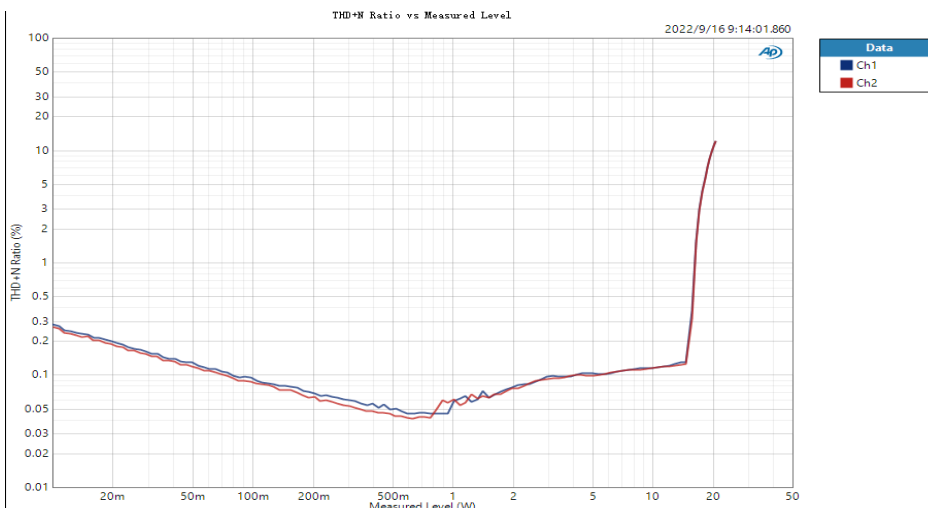

$V_{DD} = 12\text{V}$, Load = 4ohm,
Output power vs THD+N

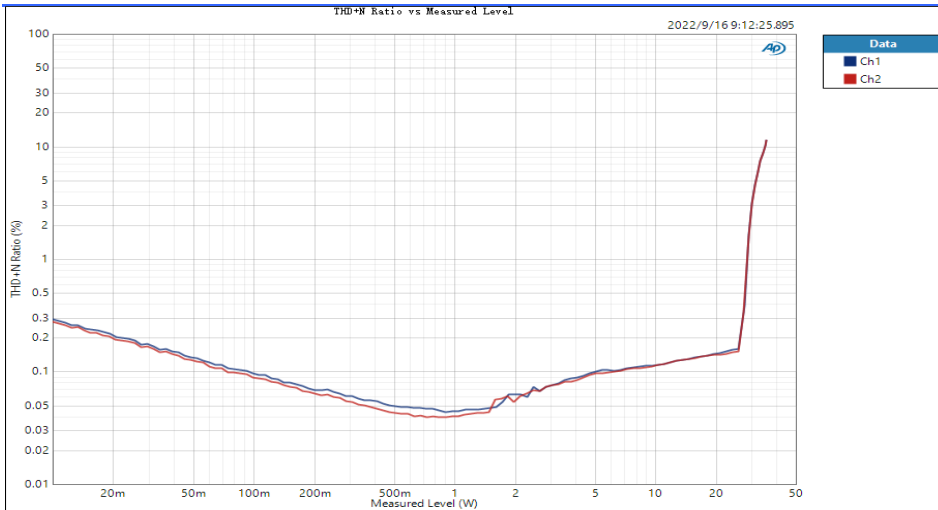

Output power vs THD+N
VDD = 16V, Load = 4R

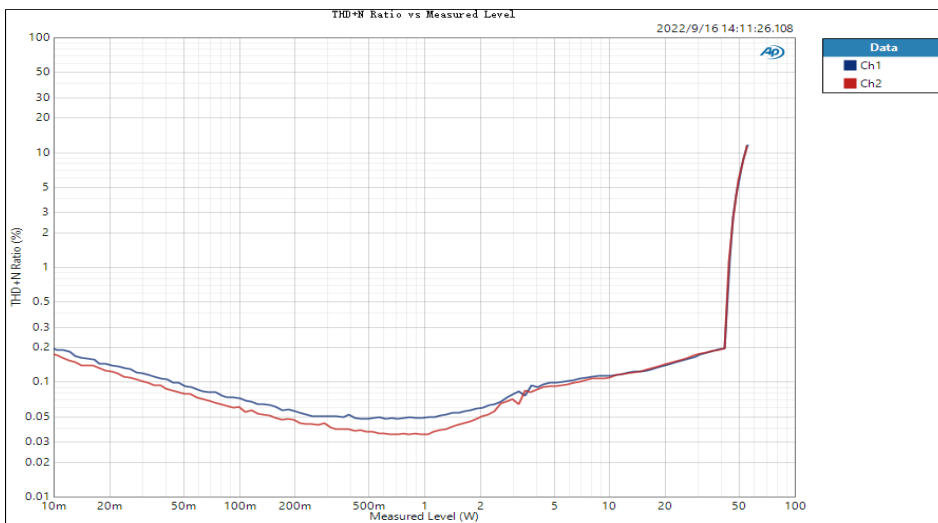

Output power vs THD+N
VDD = 20V, Load = 4R

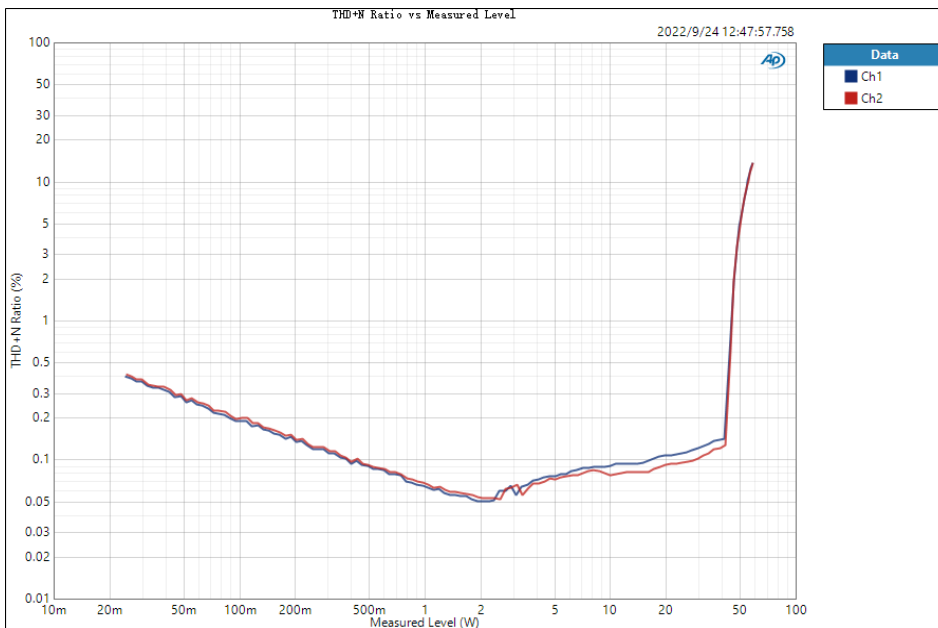

Output power vs THD+N
VDD = 24V, Load = 6R

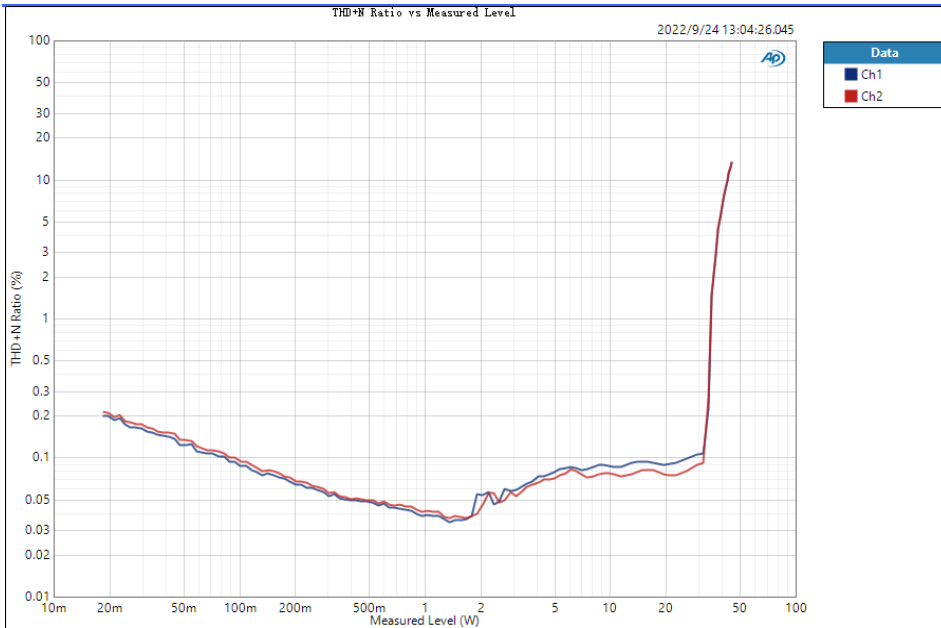

Output power vs THD+N
VDD = 24V, Load = 8R

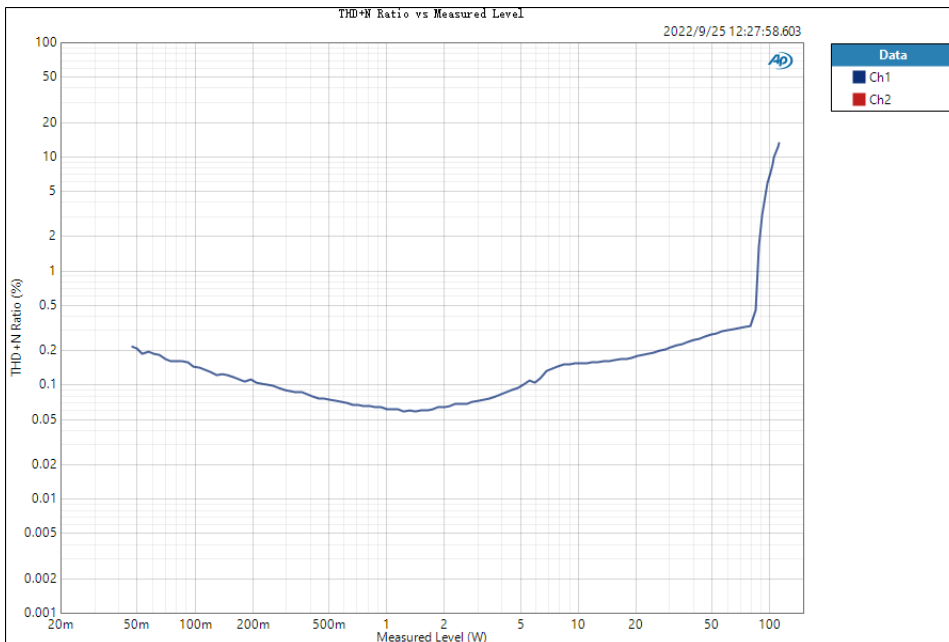

Output power vs THD+N
VDD = 24V, Load = 3R

APPLICATION INFORMATION

1 Power Supply

The power supply for the HT338 only require one voltage from 4.5V to 26V, which supplies the analog circuitry and the power stage

The AVDD supply feeds internal LDO including GVDD. This LDO output is connected to external pins for filtering purposes, but should not be connected to external circuits. The filtering capacitor for GVDD is recommended to be 1uF.

The PVDD (pin27/pin28) feeds the power stage of L channel and the PVDD (pin15/pin16) feeds the power stage of R channel. Filtering capacitors of 100nF//1uF//220uF for PVDD of each channel should be placed close to the PVDD pin and PGND.

2 Amplifier Input and Output

2.1 Amplifier Input Configuration

HT338 is an amplifier with analog input (single-ended or differential).

For a differential operation, input signals into INP and INN pins via DC-cut capacitors (C_{IN}) and external input resistors R_{EIN} . See as figure 1. The system gain can be calculated by $Gain \approx 20 \times \log\left(\frac{R_F}{R_{IIN} + R_{EIN}}\right)$, where $R_F = 400k$, $R_{IIN} = 10k$ if Gain pin = H or floating, $R_{IIN} = 20k$ if Gain pin = L. And the high pass cut-off frequency of input signal can be calculated by $f_c = \frac{1}{2\pi(R_{IIN} + R_{EIN}) \times C_{IN}}$.

For a single-ended operation, input signals to INP pin via a DC-cut capacitor (C_{IN}) and external input resistor (R_{EIN}). INN pin should be connected to ground via a DC-cut capacitor and external input resistor (with the same value of C_{IN} and R_{EIN}). See as figure 2. The Gain and high pass Cut-off frequency are the same as the above case.

HT338 的电源只需要一个 4.5V 到 26V 的电压，用于提供模拟电路和功率电路。

AVDD 电源为内部 LDO(包括 GVDD)供电。这个 LDO 输出连接到外部引脚用于滤波，但不应该连接到外部电路。GVDD 的滤波电容建议为 1uF。

PVDDL (pin27/pin28)为 L 通道的功率级供电，PVDDR (pin15/pin16)为 R 通道的功率级供电。每个通道 PVDD 的 100nF//1uF//220uF 滤波电容应放置在 PVDD 引脚和 PGND 引脚附近。

HT338 接受模拟差分或单端音频信号输入，产生 PWM 脉冲输出信号驱动扬声器。

对差分输入，通过隔直电容 C_{IN} 和输入电阻 R_{EIN} 分别输入到 INP 和 INN 端，见图 1。系统增益 $Gain \approx 20 \times \log\left(\frac{R_F}{R_{IIN} + R_{EIN}}\right)$ ， $R_F = 400k$ ， $R_{IIN} = 10k$ (Gain 脚为高或悬空时)， $R_{IIN} = 20k$ (Gain 脚为低时)。高通滤波器截止频率为 $f_c = \frac{1}{2\pi(R_{IIN} + R_{EIN}) \times C_{IN}}$ 。

对单端输入，则通过 C_{IN} 耦合到 INP 端。INN 端必须通过输入电阻和电容（与 C_{IN} 、 R_{EIN} 值相同）接地，见图 2。增益 Gain 和截止频率 f_c 与差分输入时相同。。

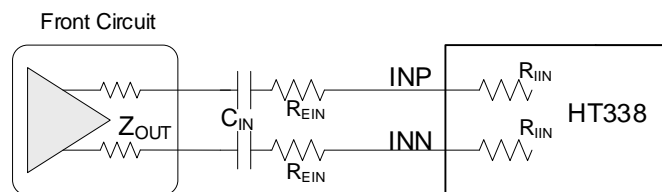

Figure 1 Differential Input configuration

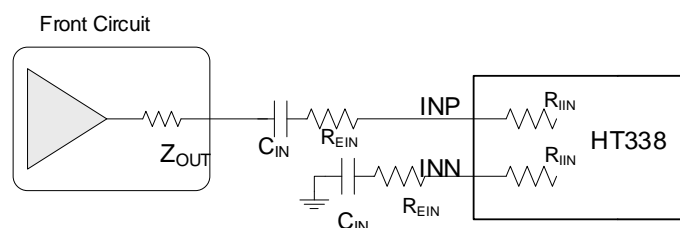

Figure 2 Single-ended Input configuration

2.2 Amplifier Output Configuration

The HT338 has been tested with a simple ferrite bead filter for a variety of applications. The impedance of the ferrite bead can be used along with a small capacitor with a value in the range of 1000 pF to reduce the frequency spectrum of the signal to an acceptable level. For best performance, the resonant frequency of the ferrite bead/ capacitor filter should be less than 10 MHz. Also, the filter capacitor can be increased if necessary, with some impact on efficiency.

HT338 可使用简单的铁氧体珠过滤器, 在各种应用中。铁氧体珠的阻抗可与值在 1000 pF 范围内的小电容一起使用, 以将信号的频谱降低到可接受的范围。

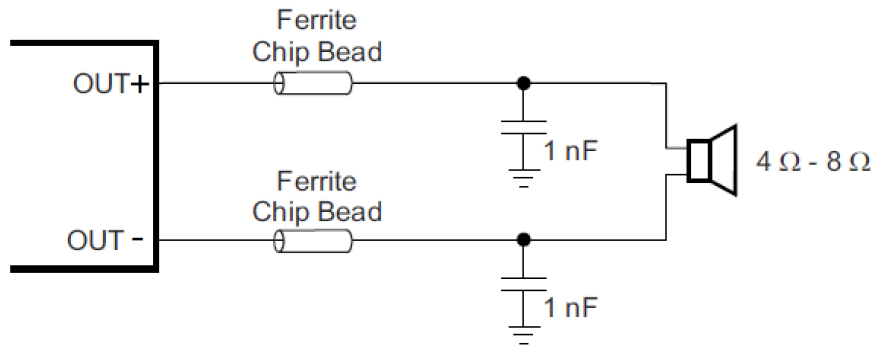

Figure 3 Output Filters with Ferrite Beads

There may be a few circuit instances where it is necessary to add a complete LC reconstruction filter. These circumstances might occur if there are nearby circuits which are sensitive to noise. In these cases, a classic second order Butterworth filter similar to those shown in the figures below can be used.

可能在一些应用场合需要添加一个完整的 LC 滤波器, 比如附近有对噪声敏感的电路, 或 EMI 难以达到标准。此时, 可以使用类似于下图所示的经典二阶巴特沃斯滤波器。

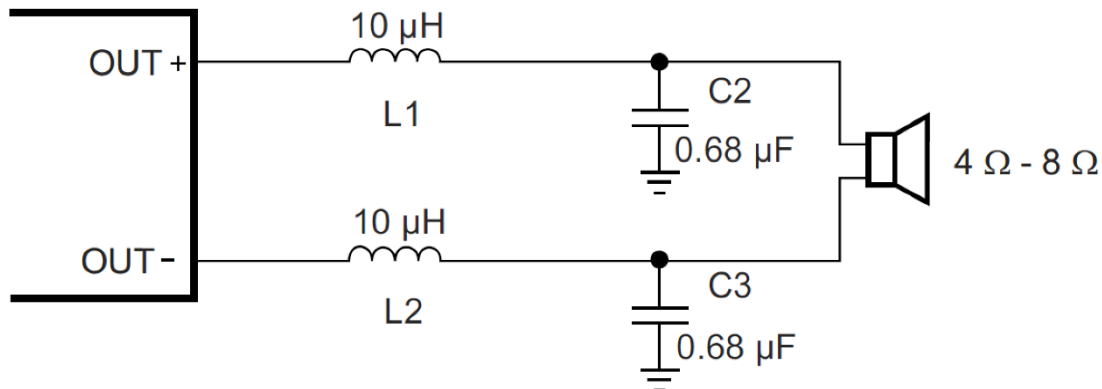

Figure 4 Output Filters with LC

2.3 PBTL Mode Configuration

The HT338 can be configured to drive a single speaker with the two output channels connected in parallel. This mode of operation is called Parallel Bridge Tied Load (PBTL) mode. This mode of operation effectively reduces the output impedance of the amplifier in half, which in turn reduces the power dissipated in the device due to conduction losses through the output FETs. Additionally, since the output channels are working in parallel, it also doubles the amount of current the speaker amplifier can source before hitting the over-current error threshold.

To place the HT338 into PBTL Mode, the LINP and LINN pin should be directly connected to Ground. When operated in PBTL mode, the output pins should be connected as shown in the Typical Application Circuit Diagrams.

In PBTL mode, the amplifier accepts its source signal from the R channel of the stereo signal.

HT338 可工作在单声道输出的 PBTL 模式，此时两个输出通道需要并联。在这种模式下，输出线损降低了一般，从而减小了功率损耗，同时，喇叭可流过的最大电流也翻倍了。

LINP 和 LINN 直接短接至地，可使 HT338 进入 PBTL 模式，输出需要短接，参见下图。此时，信号从 R 通道进入。

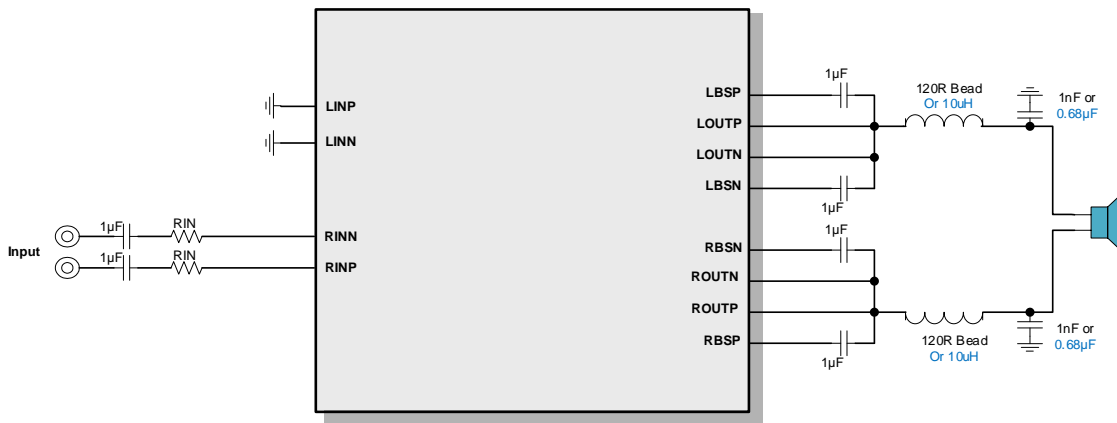

Figure 5 PBTL configuration

3 Startup, Shutdown

The HT338 employs a shutdown mode of operation designed to reduce supply current (I_{DD}) to the absolute minimum level during periods of nonuse for power conservation. The \backslash SD input terminal should be held high during normal operation when the amplifier is in use. Pulling \backslash SD low will put the outputs to mute and the amplifier to enter a low-current state. It is not recommended to leave \backslash SD unconnected and pull \backslash SD down less than 100us, because amplifier operation would be unpredictable.

For a better power on and power-off pop performance, place the amplifier in the shutdown mode prior to delivering or removing the power supply.

HT338 具有关断功能，以使芯片进入低功耗状态。当 \backslash SD 拉高时，芯片进入工作状态；当 \backslash SD 拉低时，芯片进入关断状态。

\backslash SD 不建议悬空，也不建议 \backslash SD 低电平的状态小于 100us，否则可能状态不定。

上下电时，为减小 pop 声，在上、下电前，将功放关闭进入关断状态。

4 Device Functional Mode -1SPW modulation

The 1SPW mode alters the normal modulation scheme in order to achieve higher efficiency with a slight penalty in THD degradation and more attention required in the output filter selection. In 1SPW mode the outputs operate at ~15% modulation during idle conditions. When an audio signal is applied one output decreases and the other output increases. The decreasing output signal rails to GND. At which point all the audio modulation takes place through the rising output. The result is that only one output is switching during a majority of the audio cycle. Efficiency is improved in this mode due to the reduction of switching losses.

1SPW 模式不同于传统调制方式, 以获得更高的效率, 同时对 THD 有轻微的变差, 并在输出滤波器的选择方面需要更多的注意。在 1SPW 模式下, 输出在空闲状态下以约 15% 的调制工作。当应用音频信号时, 一个输出减少, 另一个输出增加, 下降的输出信号最终降低到 GND, 此后, 所有的音频调制发生在另一个通道。结果是在音频周期的大部分时间里只有一个输出在切换。这种方式提高了效率。

5 Spread Spectrum and Shutdown

The HT338 device has built-in spread spectrum control of the oscillator frequency to improve EMI performance. The spread spectrum scheme is internally fixed and by setting the \SD pin above 2.5V to turn on.

HT338 器件内置了扩频控制, 以提高 EMI 性能。扩频方案内部固定, 通过设置 2.5V 以上的 \SD 引脚打开。

Table 1 \SD Terminal Configuration

VCTRL	Working Mode
<0.5V	Shutdown
1.8V~2.1V	Spread spectrum Disabled
2.5~5.5V	Spread spectrum Enabled

In shutdown mode, HT338 shuts all circuit down and minimizes the power consumption. And, the output terminals become Weak Low (A high resistance grounded state).

在关断模式(低功耗待机)下, 芯片关闭所有功能并将功耗降低到最小, 输出端为弱低电平状态(内部通过电阻接地)。

6 GVDD Supply

The GVDD Supply is used to power the gates of the output full bridge transistors. Decouple GVDD with a X5R ceramic 1 μF capacitor to GND. The GVDD supply is not intended to be used for external supply.

GVDD 电源用于为输出全桥晶体管的栅极供电。使用 X5R 陶瓷 1 μF 电容器将 GVDD 与 GND 连接。GVDD 电源不用于外部电源。

7 BSP and BSN Capacitors

The full H-bridge output stages use only NMOS transistors. Therefore, they require bootstrap capacitors for the high side of each output to turn on correctly. A 1uF ceramic capacitor of quality X5R or better, rated for at least 16 V, must be connected from each output to its corresponding bootstrap input. The bootstrap capacitors connected between the BSx pins and corresponding output function as a floating power supply for the high-side N-channel power MOSFET gate drive circuitry. During each high-side switching cycle, the bootstrap capacitors hold the gate-to-source voltage high enough to keep the high-side MOSFETs turned on.

全 H 桥输出级仅使用 NMOS 晶体管。因此, 它们需要引导电容器, 以使每个输出的高端正确开启。必须从每个输出端将额定电压至少为 16 V、质量为 X5R 或更高的 1uF 陶瓷电容器连接到相应的自举输入端。连接在 BSx 引脚和相应输出之间的自举电容器, 用作高端 NMOS 栅极驱动电路的电源。在每个高端开关周期中, 自举电容器保持栅极至源极电压足够高, 以保持高端 MOSFET 导通。

8 Protection Function

HT338 has the protection functions such as Over-Current Protection function, Thermal Protection function, DC Detect Protection, Under-Voltage Protection and over voltage protection.

(1) Over-current Protection function (OCP)

When a short circuit occurs between one output terminal and Ground, PVDD, or the other output, the over-current protection mode starts up. In the over current protection mode, the differential output terminal becomes a high impedance state. Once the short circuit conditions are eliminated, the over current protection mode can be cancelled automatically.

(2) Thermal Protection function (OTP)

When excessive high temperature of HT338 (150 °C) is detected, the thermal protection mode starts up. In the thermal protection mode, the differential output terminal becomes Weak Low state (a state grounded through high impedance).

(3) DC Detect Protection (DCP)

The HT338 has circuitry which will protect the speakers from DC current which might occur due to an internal amplifier error. The DC Detect fault will cause the amplifier to shutdown by changing the state of the outputs to Hi-Z.

A DCE event occurs when the output differential duty-cycle of either channel exceeds 60% for more than 420 msec at the same polarity. This feature protects the speaker from large DC currents or AC currents less than 2 Hz.

When OCP, OTP or DCP is activated, the SD/FAULT pin will be pulled low, and the error signal will be cleared. Therefore, after a delay time (Typ 1.3s), HT338 will try restart.

(4) Over-voltage Protection function (OVP)

The HT338 device monitors the voltage on AVDD voltage. When the voltage on AVDD pin exceeds the over-voltage threshold (32V typ), the OVP circuit puts the device into shutdown mode. The device recovers automatically once the over-voltage condition has been removed.

(5) Under-Voltage Protection (UVP)

This is the function to establish the under-voltage protection mode when power supply becomes lower than the detection voltage V_{UVLL} (Typ 4.2V), and the protection mode is canceled when the power supply becomes higher than the threshold voltage V_{UVLH} (Typ 4.4V). In the under-voltage protection mode, the differential output pin becomes weak low state (a stage grounded through resistivity). HT338 will start up within start-up time when the under-voltage protection mode is cancelled.

HT338 具有以下几种保护功能：输出端过流保护、片内过温保护、直流监测保护、欠压保护、过压保护。

(1) 过流保护

当检测到一输出端对电源、对地、或对另一输出端短路时，过流保护启动，输出端切换至高阻态，防止芯片烧毁损坏。短路情况消除后，通过关断、唤醒一次芯片，或重新上电均能使芯片退出保护模式。

(2) 过温保护

当检测到芯片内温度超过 150 °C 时，过温保护启动，正负输出端切换至弱低电平状态（内部通过高阻接地），防止芯片被热击穿损坏。

(3) 直流监测保护

HT338 具有保护扬声器免受由于内部放大器错误而产生的直流电流影响的电路。直流检测故障时，输出状态更改为 Hi-Z，致放大器关闭。

当任一通道在相同极性下的输出差占空比超过 60% 超过 420 毫秒时，就会发生 DCE 事件。此功能可保护扬声器免受大直流电流或小于 2 Hz 的交流电流的影响。

当 OCP、OTP 或 DCP 发生时，\SD/FAULT 引脚拉低，错误信号清除。因此，经过一段延迟时间(Typ 1.3s)后，HT338 将尝试重启。

(4) 过压保护

HT338 监控 AVDD 电压上的电压。当 AVDD 引脚上的电压超过过电压阈值(32V 典型值)时，OVP 电路将 HT338 置于关机模式。一旦消除过电压情况，设备将自动恢复。

(5) 欠压保护

该功能是在当电源低于检测电压 V_{UVLL} (Typ 4.2V) 时建立欠压保护模式，当电源高于阈值电压 V_{UVLH} (Typ 4.4V) 时取消保护模式。在欠压保护模式下，输出引脚变为弱下拉状态(通过电阻接地)。取消欠压保护模式后，HT338 会在启动时间内启动。

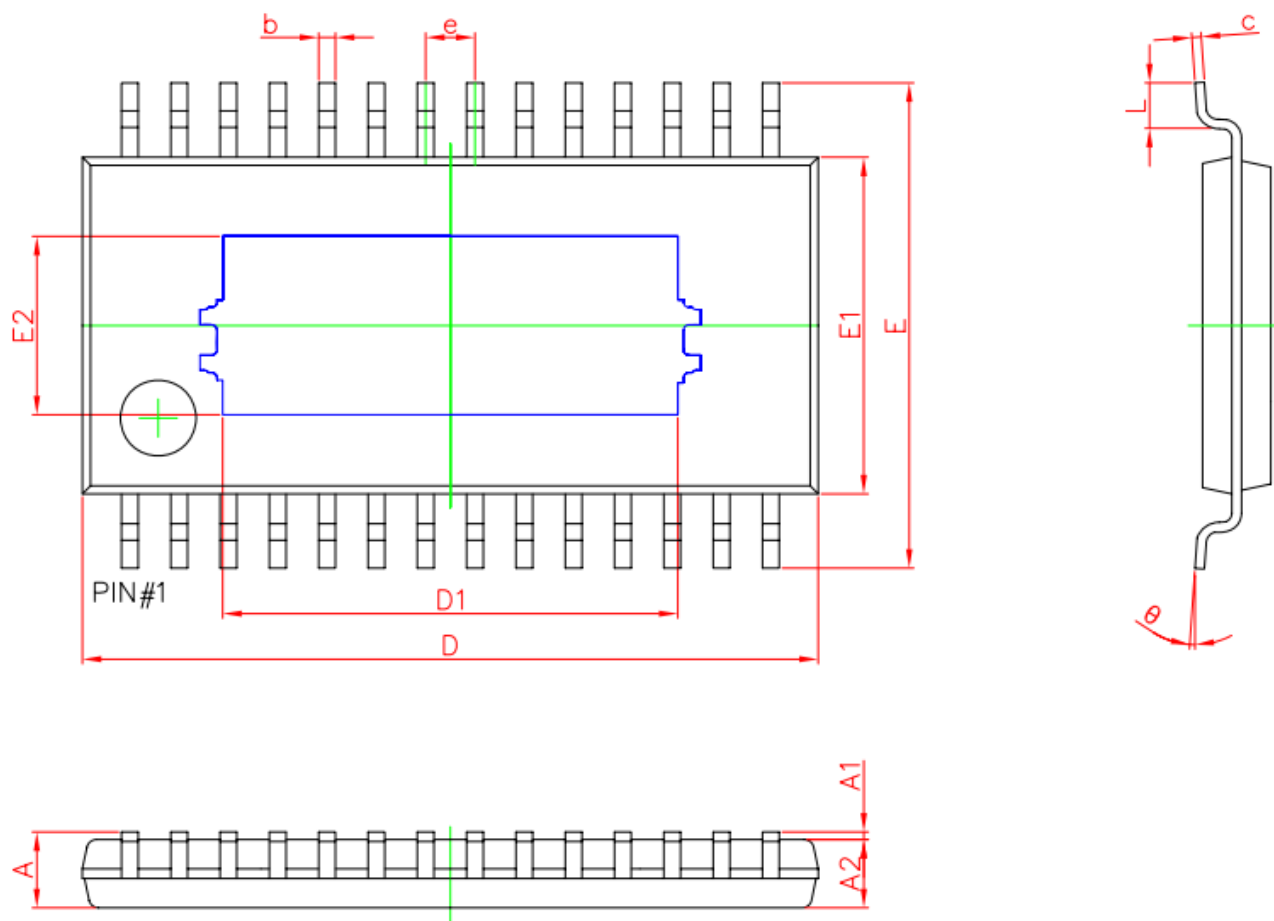
PACKAGE OUTLINE
MTE (ETSSOP28)

SYMBOL	MILLIMETER	
	MIN	MAX
A	/	1.200
A1	0	0.1
A2	0.800	1.050
b	0.190	0.300
c	0.090	0.200
D	9.600	9.800
D1	5.908	6.108
E	6.250	6.550
E1	4.300	4.500
E2	2.253	2.453
e	0.650BSC	
L	0.450	0.750
θ	0°	8°

IMPORTANT NOTICE**注意**

Heroic Electronic Technology (Jiaxing) Co., Ltd (HT) reserves the right to make corrections, modifications, enhancements, improvements, and other changes to its products and services at any time and to discontinue any products or services. Customers should obtain the latest relevant information before placing orders and should verify that such information is current and complete.

禾润电子科技（嘉兴）股份有限公司（以下简称HT）保留对产品、服务、文档的任何修改、更正、提高、改善和其他改变，或停止提供任何产品和服务的权利。客户在下单和生产前应确保所得到的信息是最新、最完整的。

HT assumes no liability for applications assistance or customer product design. Customers are responsible for their products and applications using HT components.

HT对相关应用的说明和协助以及客户产品的板级设计不承担任何责任。

HT products are not authorized for use in safety-critical applications (such as life support devices or systems) where a failure of the HT product would reasonably be expected to affect the safety or effectiveness of that devices or systems.

HT的产品并未授权用于诸如生命维持设备等安全性极高的应用中。

The information included herein is believed to be accurate and reliable. However, HT assumes no responsibility for its use; nor for any infringement of patents or other rights of third parties which may result from its use.

本文中的相关信息是精确和可靠的，但HT并不对其负责，也不对任何可能的专利和第三方权利的侵害负责。

Following are URLs and contacts where you can obtain information or supports on any HT products and application solutions:

下面是可以联系到我公司的相关链接和联系方式：

禾润电子科技（嘉兴）股份有限公司
Heroic Electronic Technology (Jiaxing) Co., Ltd.

地址：浙江省嘉兴市凌公塘路3339号JRC大厦A座三层

Add: A 3rd floor, JRC Building, No. 3339, LingGongTang Road, Jiaxing, Zhejiang Province

Sales: 0573-82585539, sales@heroic.com.cn

Support: 0573-82586151, support@heroic.com.cn

Fax: 0573-82585078

Website: www.heroic.com.cn; wap.heroic.com.cn

Wechat MP: HEROIC_JX

请及时关注禾润官方微信公众号，随时获取最新产品信息和技术资料！

