

18V 2A 500KHz Synchronous Step-Down Regulator

Features

- Wide 4V to 18V Operating Input Range
- 2A Continuous Output Current
- 500KHz Switching Frequency
- Short Protection with Hiccup-Mode
- Built-in Over Current Limit
- Built-in Over Voltage Protection
- Internal Power-Save Mode (PFM/PWM)
- Internal Soft-Start
- 110mΩ/70mΩ Low RDS(ON) Internal Power MOSFETs
- Output Adjustable from 0.6V
- No Schottky Diode Required
- Integrated internal compensation
- Thermal Shutdown
- Available in SOT23-6 Package
- -40°C to +85°C Temperature Range

Applications

- Digital Set-top Box (STB)
- Tablet Personal Computer (Pad)
- Flat-Panel Television and Monitor
- Wi-Fi Router / AP
- Digital Video Recorder (DVR)
- Portable Media Player (PMP)
- Cable Modem / XDSL
- General Purposes

General Description

The RY8120 is a high frequency, synchronous, rectified, step-down, switch-mode converter with internal power MOSFETs. It offers a very compact solution to achieve a 3A peak output current over a wide input supply range, with excellent load and line regulation.

The RY8120 requires a minimal number of readily available, external components and is available in a space saving SOT23-6 package.

Typical Application Circuit

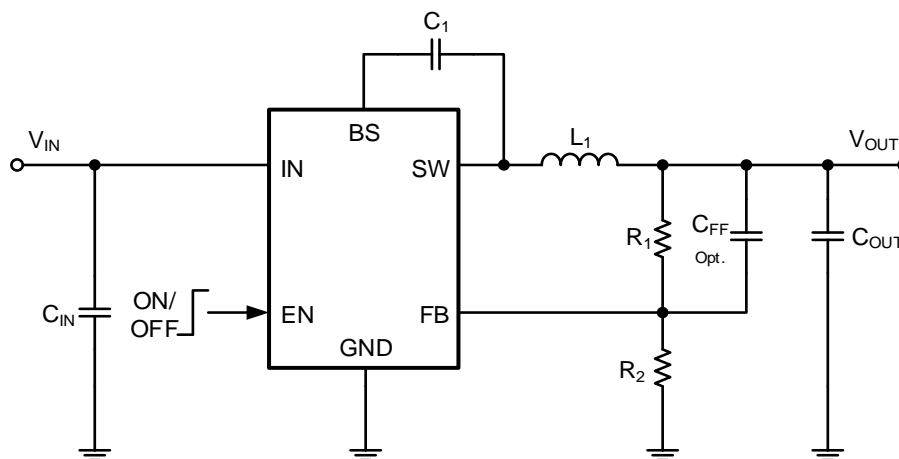

Basic Application Circuit

18V 2A 500KHz Synchronous Step-Down Regulator

Pin Description

Pin Configuration

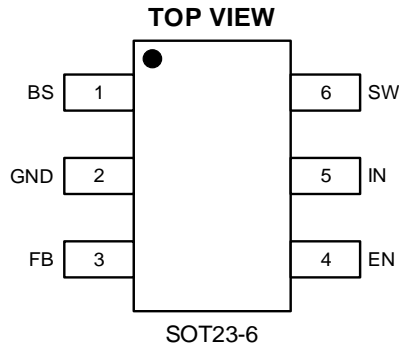

Top Marking: BCYLL (device code: BC, Y=year code, LL= lot number code)

Pin Description

Pin	Name	Function
1	BS	Bootstrap. A capacitor connected between SW and BST pins is required to form a floating supply across the high-side switch driver.
2	GND	GROUND Pin
3	FB	Adjustable Version Feedback input. Connect FB to the center point of the external resistor divider
4	EN	Drive this pin to a logic-high to enable the IC. Drive to a logic-low to disable the IC and enter micro-power shutdown mode.
5	IN	Power Supply Pin
6	SW	Switching Pin

Order Information

Marking	Part No.	Model	Description	Package	T/R Qty
BCYLL	70301024	RY8120	RY8120 Buck, 4-18V, 2A, 500KHz, VFB 0.6V, SOT23-6	SOT23-6	3000PCS

18V 2A 500KHz Synchronous Step-Down Regulator

Absolute Maximum Ratings ⁽¹⁾ ⁽²⁾

V _{IN} , EN, Voltage	-0.3V to 21V	V _{SW} Voltage	-0.3V to (V _{IN} +0.5V)
V _{FB} Voltages	-0.3 to 6V	V _{BS} Voltage	(V _{sw} -0.3) to (V _{sw} +5V)
Operating Temperature Range	-40°C to +85°C	Storage Temperature Range	-65°C to 150°C
Lead Temperature (Soldering, 10s)	+300°C	Junction Temperature.....	+150°C
θ _{JA}	170°C/W	ESD (Human Body Made) HMB.....	2KV
θ _{JC}	110°C/W	ESD (Machine Made) MM.....	200V

Note1: Exceeding these ratings may damage the device.

Note2: The device is not guaranteed to function outside of its operating conditions.

Electrical Characteristics ⁽³⁾ ⁽⁴⁾

V_{IN} = 12V, T_A = +25°C, unless otherwise noted.

Parameter	Test Conditions	Min	Typ.	Max	Unit
Input Voltage Range		4		18	V
Supply Current in Operation	V _{EN} =3.0V, V _{FB} =1.1V		0.4	0.8	mA
Supply Current in Shutdown	V _{EN} = 0 or EN = GND			10	uA
Regulated Feedback Voltage	T _J = -40°C to +125°C	0.591	0.6	0.609	V
High-Side Switch On-Resistance			110		mΩ
Low-Side Switch On-Resistance			70		mΩ
High-Side Switch Leakage Current	V _{EN} =0V, V _{SW} =0V			10	uA
Upper Switch Current Limit	Minimum Duty Cycle		3		A
Oscillation Frequency			500		kHz
Maximum Duty Cycle	V _{FB} =0.6V		92		%
Minimum On-Time			60		nS
Minimum Off-Time			90		nS
EN Input Current	V _{EN} =2V		1		uA
	V _{EN} =0V		0		uA
VIN Under-Voltage Lockout Threshold	INUV _{TH}	3.5		3.8	V
VIN Under-Voltage Lockout Threshold-Hysteresis	INUV _{HYS}		200		mV
EN up Threshold	V _{EN} -Rising	1.05	1.15	1.25	V
EN Threshold Hysteresis			140		mV
Soft Start		1		2	mS
Hiccup Frequency	V _{OUT} = 3.3V, V _{IN} = 12V	80		120	Hz
Hiccup Duty cycle	V _{OUT} = 3.3V, V _{IN} = 12V		40		%
Thermal Shutdown			160		°C
Thermal Hysteresis			20		°C

Note3: MOSFET on-resistance specifications are guaranteed by correlation to wafer level measurements.

Note4: Thermal shutdown specifications are guaranteed by correlation to the design and characteristics analysis.

18V 2A 500KHz Synchronous Step-Down Regulator

Typical Performance Characteristics (5) (6)

Note (5): Performance waveforms are tested on the evaluation board.

Note (6): $V_{IN}=12V$, $V_{OUT}=3.3V$, $T_A = +25^{\circ}C$, unless otherwise noted.

Efficiency vs Load Current

$V_{OUT} = 3.3V$

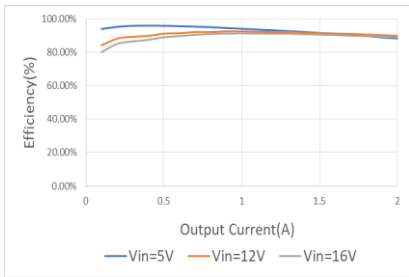

Load Regulation

$V_{OUT} = 3.3V$

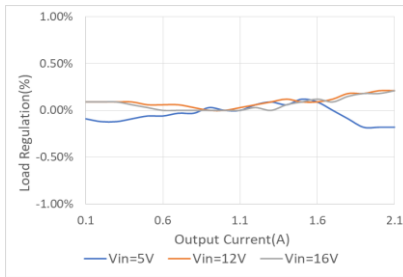

Line Regulation

$V_{OUT} = 3.3V$

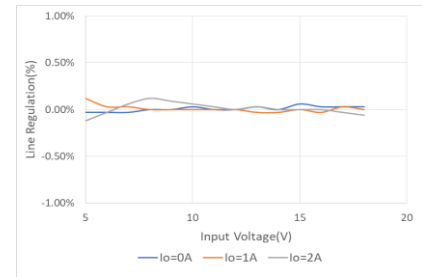

Output Ripple Voltage

$V_{IN} = 12V$, $V_{OUT} = 3.3V$, $I_{OUT} = 0A$

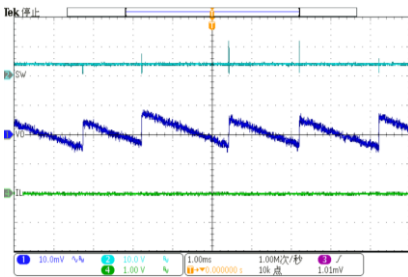

Output Ripple Voltage

$V_{IN} = 12V$, $V_{OUT} = 3.3V$, $I_{OUT} = 1.0A$

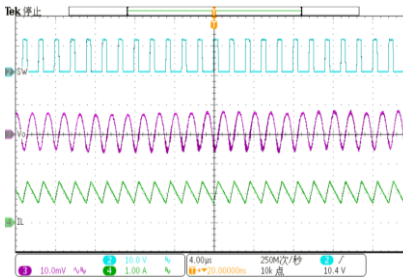

Output Ripple Voltage

$V_{IN} = 12V$, $V_{OUT} = 3.3V$, $I_{OUT} = 2.0A$

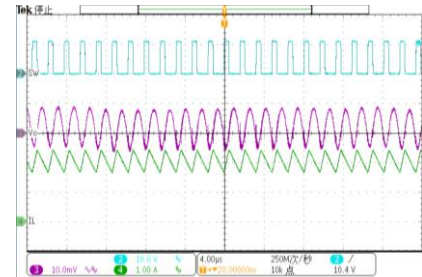

Loop Response

$V_{IN} = 12V$, $V_{OUT} = 3.3V$, $I_{OUT} = 1.0A-2.0A$

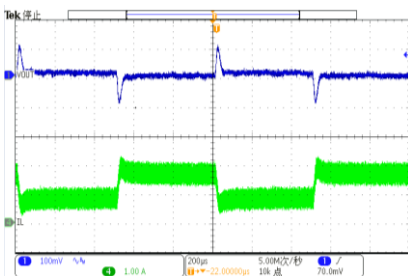

Hiccup with Output Short

$V_{IN} = 12V$, $V_{OUT} = 3.3V$

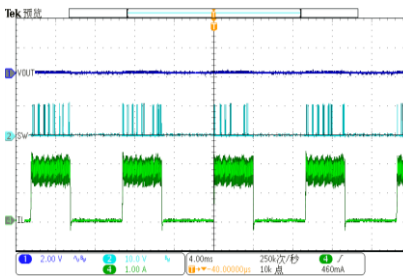

Short Circuit Entry

$V_{IN} = 12V$, $V_{OUT} = 3.3V$

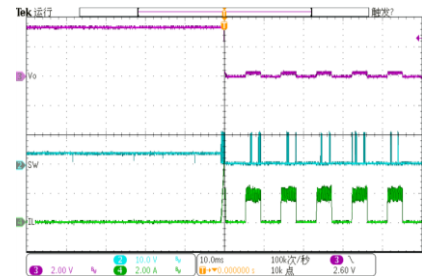

18V 2A 500KHz Synchronous Step-Down Regulator

Short Circuit Recovery

$V_{IN} = 12V, V_{OUT} = 3.3V$

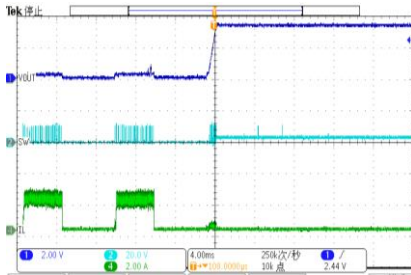

Enable Startup at No Load

$V_{IN} = 12V, V_{OUT} = 3.3V, I_{OUT} = 0A$

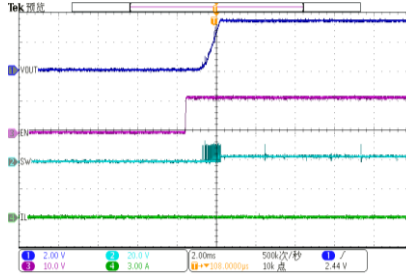

Enable Shutdown at No Load

$V_{IN} = 12V, V_{OUT} = 3.3V, I_{OUT} = 0A$

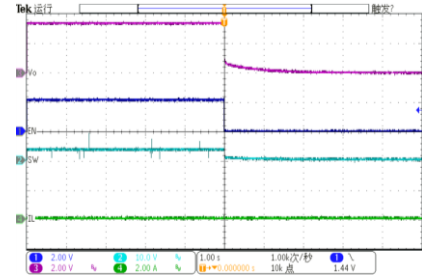

Enable Startup at Full Load

$V_{IN} = 12V, V_{OUT} = 3.3V, I_{OUT} = 2.0A$

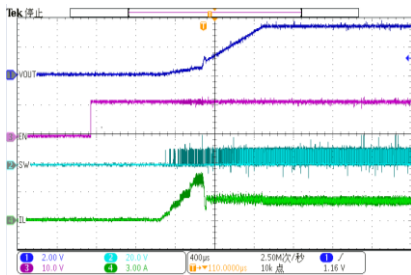

Enable Shutdown at Full Load

$V_{IN} = 12V, V_{OUT} = 3.3V, I_{OUT} = 2.0A$

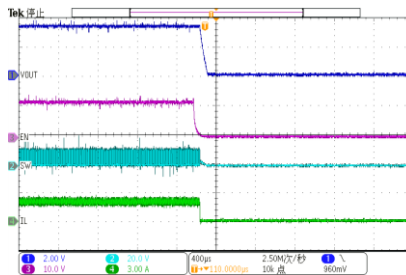

Power Up at No Load

$V_{IN} = 12V, V_{OUT} = 3.3V, I_{OUT} = 0A$

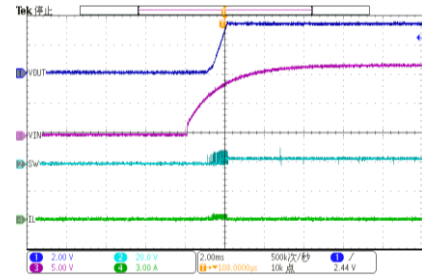

Power Up at Full Load

$V_{IN} = 12V, V_{OUT} = 3.3V, I_{OUT} = 2.0A$

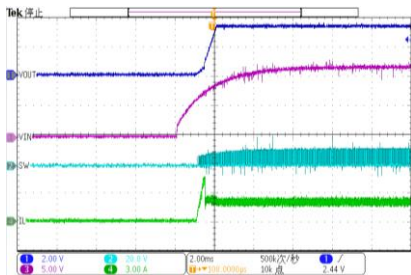

18V 2A 500KHz Synchronous Step-Down Regulator

Functional Block Diagram

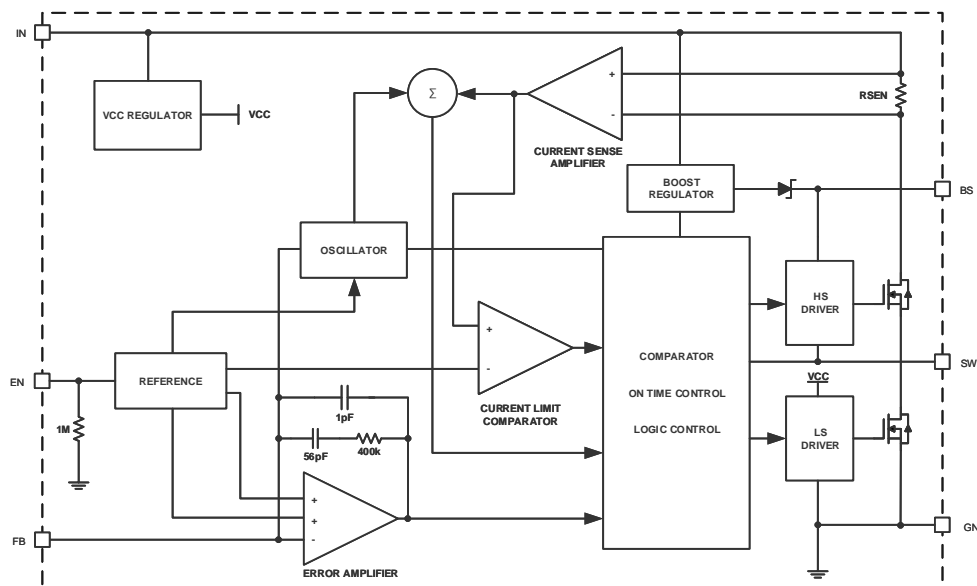

Figure 2. RY8120 Block Diagram

Functions Description

Internal Regulator

The RY8120 is a current mode step down DC/DC converter that provides excellent transient response with no extra external compensation components. This device contains an internal, low resistance, high voltage power MOSFET, and operates at a high 500KHz operating frequency to ensure a compact, high efficiency design with excellent AC and DC performance.

Error Amplifier

The error amplifier compares the FB pin voltage with the internal FB reference (VFB) and outputs a current proportional to the difference between the two. This output current is then used to charge or discharge the internal compensation network, which is used to control the power MOSFET current. The optimized internal compensation network minimizes the external component counts and simplifies the control loop design.

Internal Soft-Start

The soft-start is implemented to prevent the converter output voltage from overshooting during startup. When the chip starts, the internal circuitry generates a soft-start voltage (SS) ramping up from 0V to 0.6V. When it is lower than the internal reference (REF), SS overrides REF so the error amplifier uses SS as the reference. When SS is higher than REF, REF regains control. The SS time is internally max to 1.2ms.

Over Current Protection & Hiccup

The RY8120 has cycle-by-cycle over current limit when the inductor current peak value exceeds the set current limit threshold. Meanwhile, output voltage starts to drop until FB is below the Under-Voltage (UV) threshold, typically 25% below the reference. Once a UV is triggered, the RY8120 enters hiccup mode to periodically restart the part. This protection mode is especially useful when the output is dead-short to ground. The average short circuit

18V 2A 500KHz Synchronous Step-Down Regulator

current is greatly reduced to alleviate the thermal issue and to protect the regulator. The RY8120 exits the hiccup mode once the over current condition is removed.

Startup and Shutdown

If both VIN and EN are higher than their appropriate thresholds, the chip starts. The reference block starts first, generating stable reference voltage and currents, and then the internal regulator is enabled. The regulator provides stable supply for the remaining circuitries. Three events can shut down the chip: EN low, VIN low and thermal shutdown. In the shutdown procedure, the signaling path is first blocked to avoid any fault triggering. The comp voltage and the internal supply rail are then pulled down. The floating driver is not subject to this shutdown command.

Applications Information

Setting the Output Voltage

RY8120 require an input capacitor, an output capacitor and an inductor. These components are critical to the performance of the device. RY8120 are internally compensated and do not require external components to achieve stable operation. The output voltage can be programmed by resistor divider.

$$V_{OUT} = V_{FB} \times \frac{R1 + R2}{R2}$$

V _{OUT} (V)	R1(KΩ)	R2(KΩ)	L1(μH)	C1(nF)	C _{IN} (μF)	C _{OUT} (μF)	C _{FF} (pF) Opt.
1.0	6.67	10	1.5	22-100	22	22×2	100-220
1.05	7.50	10	1.5	22-100	22	22×2	100-220
1.2	10.00	10	1.5	22-100	22	22×2	100-220
1.5	15.00	10	1.5	22-100	22	22×2	100-220
1.8	20.00	10	2.2	22-100	22	22×2	100-220
2.5	31.67	10	2.2	22-100	22	22×2	100-220
3.3	45.00	10	3.3	22-100	22	22×2	100-220
5.0	73.33	10	4.7	22-100	22	22×2	100-220

Selecting the Inductor

The recommended inductor values are shown in the Application Diagram. It is important to guarantee the inductor core does not saturate during any foreseeable operational situation. The inductor should be rated to handle the peak load current plus the ripple current: Care should be taken when reviewing the different saturation current ratings that are specified by different manufacturers. Saturation current ratings are typically specified at 25°C, so ratings at maximum ambient temperature of the application should be requested from the manufacturer.

$$L = \frac{V_{OUT} \times (V_{IN} - V_{OUT})}{V_{IN} \times \Delta I_L \times F_{OSC}}$$

Where ΔIL is the inductor ripple current. Choose inductor ripple current to be approximately 30% if the maximum load current. The maximum inductor peak current is:

18V 2A 500KHz Synchronous Step-Down Regulator

$$I_{L(MAX)} = I_{LOAD} + \frac{\Delta I_L}{2}$$

Under light load conditions below 100mA, larger inductance is recommended for improved efficiency.

Selecting the Output Capacitor

Special attention should be paid when selecting these components. The DC bias of these capacitors can result in a capacitance value that falls below the minimum value given in the recommended capacitor specifications table.

The ceramic capacitor's actual capacitance can vary with temperature. The capacitor type X7R, which operates over a temperature range of -55°C to $+125^{\circ}\text{C}$, will only vary the capacitance to within $\pm 15\%$. The capacitor type X5R has a similar tolerance over a reduced temperature range of -55°C to $+85^{\circ}\text{C}$. Many large value ceramic capacitors, larger than 1 μF are manufactured with Z5U or Y5V temperature characteristics. Their capacitance can drop by more than 50% as the temperature varies from 25°C to 85°C . Therefore X5R or X7R is recommended over Z5U and Y5V in applications where the ambient temperature will change significantly above or below 25°C .

Tantalum capacitors are less desirable than ceramic for use as output capacitors because they are more expensive when comparing equivalent capacitance and voltage ratings in the 0.47 μF to 44 μF range. Another important consideration is that tantalum capacitors have higher ESR values than equivalent size ceramics. This means that while it may be possible to find a tantalum capacitor with an ESR value within the stable range, it would have to be larger in capacitance (which means bigger and more costly) than a ceramic capacitor with the same ESR value. It should also be noted that the ESR of a typical tantalum will increase about 2:1 as the temperature goes from 25°C down to -40°C , so some guard band must be allowed.

PC Board Layout Consideration

PCB layout is very important to achieve stable operation. It is highly recommended to duplicate EVB layout for optimum performance. If change is necessary, please follow these guidelines for reference.

1. Keep the path of switching current short and minimize the loop area formed by Input capacitor, high-side MOSFET and low-side MOSFET.
2. Bypass ceramic capacitors are suggested to be put close to the Vin Pin.
3. Ensure all feedback connections are short and direct. Place the feedback resistors and compensation components as close to the chip as possible.
4. VOUT, SW away from sensitive analog areas such as FB.
5. Connect IN, SW, and especially GND respectively to a large copper area to cool the chip to improve thermal performance and long-term reliability.

18V 2A 500KHz Synchronous Step-Down Regulator

Package Description

SOT23-6

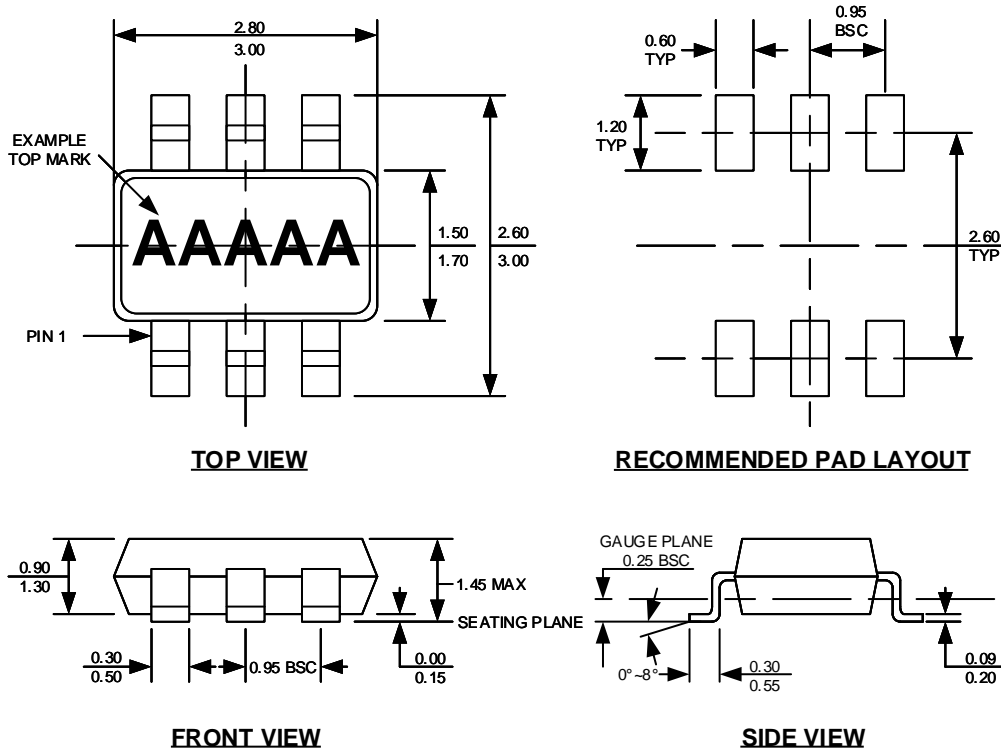

NOTE:

1. CONTROL DIMENSION IS IN INCHES. DIMENSION IN BRACKET IS IN MILLIMETERS.
2. PACKAGE LENGTH DOES NOT INCLUDE MOLD FLASH, PROTRUSIONS OR GATE BURRS.
3. PACKAGE WIDTH DOES NOT INCLUDE INTERLEAD FLASH OR PROTRUSIONS.
4. LEAD COPLANARITY (BOTTOM OF LEADS AFTER FORMING) SHALL BE 0.004" INCHES MAX.
5. DRAWING CONFORMS TO JEDEC MS-012, VARIATION BA.
6. DRAWING IS NOT TO SCALE.